

Wire Wound Type Common Mode Filter

WCM4532F2SV-SERIES

1. Features

1. High common mode impedance at high frequency cause excellent noise suppression performance.
2. WCM4532F2SV series realizes small size and low profile. 4.5x3.2x2.8 mm.
3. 100% Lead(Pb) & Halogen-Free and RoHS compliant.
4. High reliability -Reliability tests comply with AEC-Q200
5. Operating temperature-55~+125°C (Including self - temperature rise)



2. Dimension

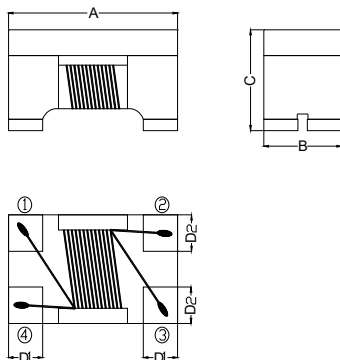

Recommended PC Board Pattern

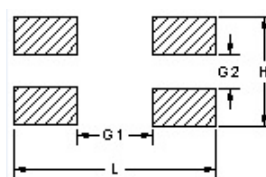

Series	A(mm)	B(mm)	C(mm)	D1(mm)	D2(mm)	L(mm)	H(mm)	G1(mm)	G2(mm)
4532F2SV	4.5±0.2	3.2±0.2	2.8±0.2	1.0±0.1	1.2±0.1	4.8	3.8	2.5	0.7

Units: mm

3. Part Numbering

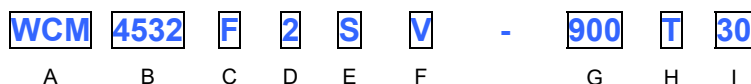

- A: Series
 B: Dimension
 C: Material Ferrite Core
 D: Number of Lines 2=2 lines
 E: Type S=Shielded , N=Unshielded
 F: Category Code V=Vehicle
 G: Impedance 900=90Ω
 H: Packaging T=Taping and Reel
 I: Rated Current 30=300mA

4. Specification

TAI-TECH Part Number	Common mode Impedance (Ω)	Test Frequency (MHz)	DC Resistance (Ω) max.	Rated Current (mA) max.	Rated Volt. (Vdc) max.	Withstand Volt. (Vdc) max.	IR (Ω) min.
WCM4532F2SV-800T30	80±25%	100	0.05	3000	50	125	10M
WCM4532F2SV-900T30	90±25%	100	0.05	3000	50	125	10M
WCM4532F2SV-121T30	120±25%	100	0.05	3000	50	125	10M
WCM4532F2SV-201T15	200±25%	100	0.10	1500	50	125	10M
WCM4532F2SV-601T15	600±25%	100	0.24	1500	50	125	10M
WCM4532F2SV-801T10	800±25%	100	0.24	1000	50	125	10M

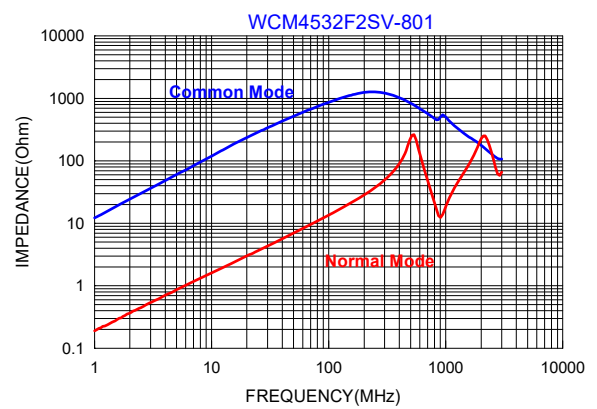
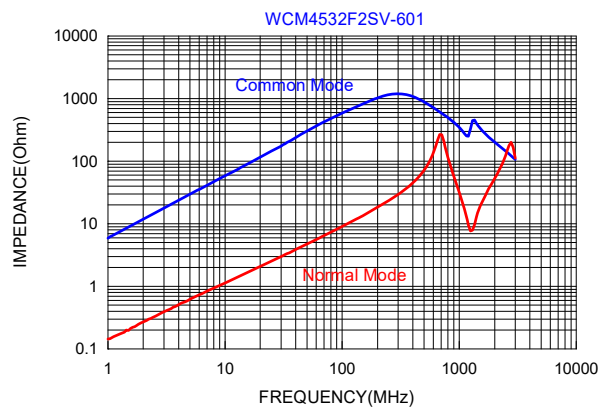
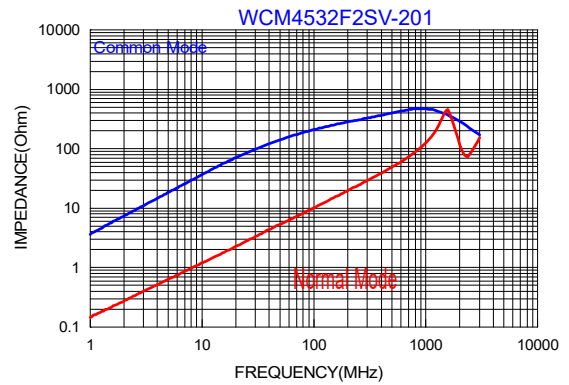
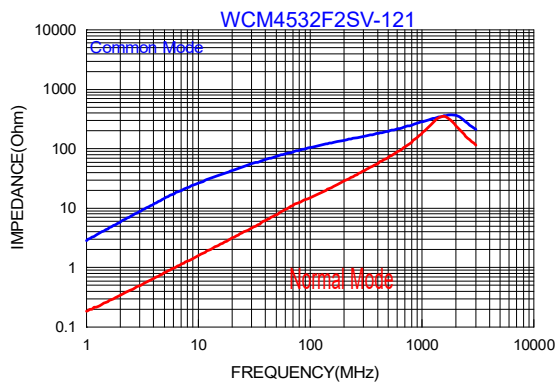
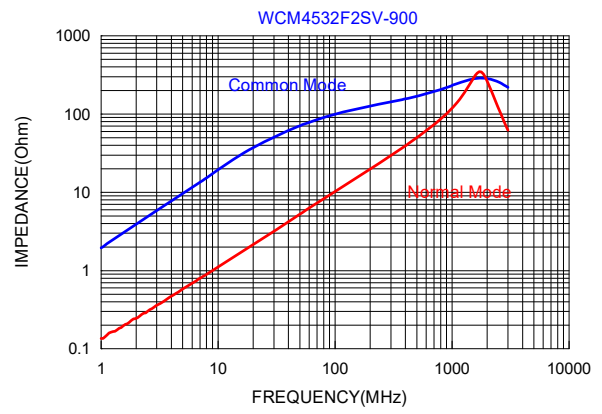
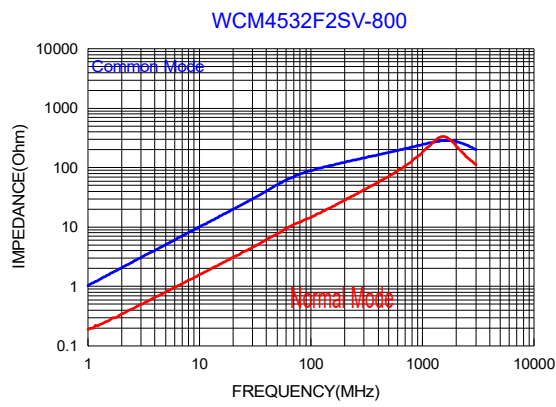

5. Schematic Diagram

